

## Fiber Optic LAN 1x5 Quad Transceiver For 850 nm 10 Mb/s with VF-45™ Connector

Data Sheet

OVF2011-2



### Features

- 850 nm LED
- Multimode fiber with VF-45™ connector
- Operating Temperature: 0 ~ +70° C
- 2 km link distance
- Compatible with Ethernet and Token Ring protocols
- Small footprint allows high density port spacing

### Applications

- Telecommunications and Data Communications System Networking
- Fiber-to the-desktop
- 10 Mb/s Ethernet
- 4/16 Mb/s Token Ring LAN

### Description

The OVF2011-2 is a 1x5 quad fiber optic transceiver module that combines a fiber optic transmitter and receiver with the VF-45™ connector, an innovative connection scheme that lends itself to high density applications by significantly reducing the board space required for a fiber optic transceiver. It operates at a data rate of 10 Mb/s over a link distance of 2 km.

The transmitter consists of a high reliability GaAlAs 850 nm LED (Light Emitting Diode) coupled to a multimode fiber through a VF-45™ connector. The LED uses a glass microlens over the Caprock junction to collimate the light and increase intensity, providing consistent power launch into fiber optic cables.

The hybrid bipolar fiber optic receiver consists of a silicon PIN (P-type/ Intrinsic/ N-type detector) photodiode for high-speed operation and a transimpedance preamplifier IC for excellent noise immunity. The device is designed to operate on the ECL (Emitter Coupled Logic) standard of -5.2 V and has excellent PSRR (Power Supply Rejection Ratio) (20 dB at 10 MHz typical). It can also be operated with a +5 V supply with a slight loss of PSRR performance at data rates below 1 MHz.

\*VF-45™ is a trademark of 3M.

\*Volition™ is a trademark of 3M.

**Safety**

**Laser Compliance Statement**

The OVF2011-2 is classified as a Class I LED Product and complies with IEC 60825-1 and FDA 21 CFR 1040.10 and 1040.11. The transceiver must be operated under recommended operating conditions. Because the transceiver is designed to be inherently eye safe, it does not require open fiber control thus eliminating complex electronics or mechanics.

Caution - use of device other than those specified herein may result in hazardous LED radiation exposure or other damage. Please embrace all customary precautions and discretion while handling this device.

**Performance Specifications**

**Absolute Maximum Ratings**

Stresses in excess of the absolute maximum ratings can cause damage to the optical device. Operations of the optical device are suggested to remain within the recommended operating conditions. Exposure to the absolute maximum ratings for extended periods can adversely affect device reliability.

Parameter	Symbol	Value	Unit
Storage Temperature	T <sub>stg</sub>	-40 to +85	°C
Operating Temperature	T <sub>op</sub>	0 to +70	°C
Soldering Temperature	S <sub>temp</sub>	260	°C
Soldering Time	S <sub>time</sub>	10	sec
Reverse Input Voltage		1.8	V
Continuous Forward Current (Heat Sunked)		100	mA
Supply Voltage	V <sub>CC</sub> -V <sub>EE</sub>	-0.5V to -6.0	V

**Recommended Operating Conditions**

Parameter	Symbol	Value	Unit
Supply Voltage	V <sub>CC</sub> -V <sub>EE</sub>	5.0 to 5.5	V
Optical Signal Input		1.0 to 100	µW

**Transmitter Electro-Optical Characteristics (T<sub>A</sub>=25°C unless otherwise noted)**

Parameter	Condition	Symbol	Min	Typ	Max	Unit
Fiber Coupled Optical Power: 50 µm fiber <sup>1,2,3</sup>	I <sub>F</sub> =32 mA peak; 50% duty cycle NA=0.20 (over temp.)	P <sub>oc</sub> (Avg.)	-21.8	-17.8	-15.8	dBm
Fiber Coupled Optical Power: 62.5 µm fiber <sup>1,2,3</sup>	I <sub>F</sub> =32 mA peak; 50% duty cycle NA=0.275 (over temp.)	P <sub>oc</sub> (Avg.)	-18.0	-14.0	-12.0	dBm
Forward Voltage	I <sub>F</sub> =32 mA DC	V <sub>F</sub>		1.60		V
	I <sub>F</sub> =60 mA DC	V <sub>F</sub>	1.48	1.70	2.09	V
Forward Voltage Temperature Coefficient	I <sub>F</sub> =32 mA DC	ΔV <sub>F</sub> /ΔT		-0.18		mV/°C
	I <sub>F</sub> =60 mA DC	ΔV <sub>F</sub> /ΔT		-0.22		mV/°C
Reverse Voltage	I <sub>R</sub> =10µA	B <sub>VR</sub>	1.8	3.8		V
Peak Wavelength	I <sub>F</sub> =32 mA DC	λ <sub>p</sub>				nm
	I <sub>F</sub> =60 mA DC	λ <sub>p</sub>	810	850	885	nm

**OVF2011-2 LAN 1x5 QUAD TRANSCEIVER DATA SHEET**

Response Time	$I_F=32$ mA Peak, No prebias	$t_R/ t_F$	4.0	6.0	ns
Po Temp Coefficient	$I_F=100$ mA $I_F=60$ mA	$\Delta P_o/\Delta T$ $\Delta P_o/\Delta T$	-0.019 -0.024		dB/°C dB/°C
Series Resistance	DC	$R_s$	4.0		$\Omega$
Device Capacitance	$V_R=0$ V; $f=1$ MHz	C	55		pF
Thermal Resistance	Heat Sinked		260		°C/W

Notes:

1. Maximum degradation at end of life = 2 dB.
2. P<sub>oc</sub> is measured using a 10 meter mode stripped cable which is intended to accurately represent a working system.
3. r.m.s  $I_f$  = 16 mA.

**FIGURE 1: TYPICAL OPTICAL POWER OUTPUT VS FORWARD CURRENT**

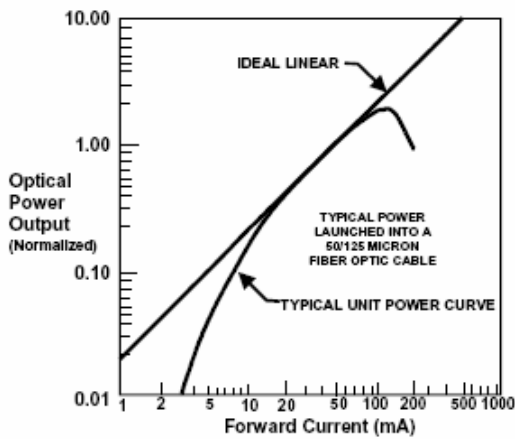

**FIGURE 2: TYPICAL SPECTRAL OUTPUT VS WAVELENGTH**

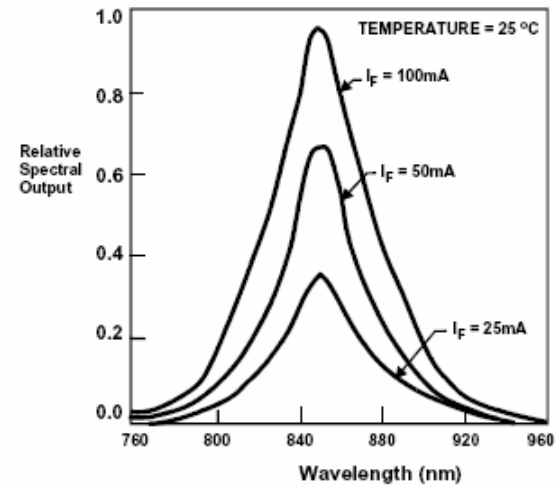

**FIGURE 3: TYPICAL OPTICAL POWER OUTPUT VS CASE TEMPERATURE**

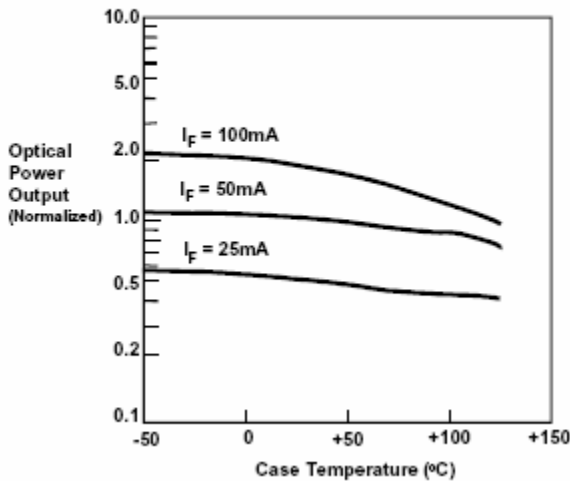

Receiver Electro-Optical Characteristics ( $T_A=0<T<70^{\circ}\text{C}$ ,  $V_{EE}=-5.2\text{V}$  unless otherwise noted)

Parameter	Condition	Symbol	Min	Typ	Max	Unit
Responsivity @ 25°C	F=10 MHz; 50% duty cycle $P_{IN}=100\ \mu\text{W}$ peak	R	5.3	7.0	9.6	mV/ $\mu\text{W}$
over temp of 0°C-70°C	$\lambda=850\ \text{nm}$ 62.5 mm core fiber	R	4.5		11.5	mV/ $\mu\text{W}$
Input Power @ 25°C	F=10 MHz; 50% duty cycle $\lambda=850\ \text{nm}$	$P_{IN}(\text{avg.})$	-34		-10.6	dBm
over temp of 0°C-70°C	PWD=2.5 nS	$P_{IN}(\text{avg.})$	0.4		87.5	$\mu\text{W}$
DC Output Voltage <sup>1</sup>	$P_{IN}\leq 0.1\ \mu\text{W}$	$V_{ODC}$	-4.0	-3.65	-3.3	V
Power Supply Current	$R_{LOAD}=0$	$I_{CC}$		9	15	mA
Rise/Fall Time @ 25°C	F=10 MHz; 50% duty cycle $P_{IN}=63\ \mu\text{W}$ avg.	$t_R/t_F$		3.6	4.5	nS
over temp of 0°C-70°C	$\lambda=850\ \text{nm}$	$t_R/t_F$		3.6	6.3	nS
Pulse Width Distortion <sup>2</sup>	F=63 MHz; 50% duty cycle $P_{IN}=63\ \mu\text{W}$ avg. $\lambda=850\ \text{nm}$	PWD		0.2	1.5	nS
Bandwidth	$\lambda=850\ \text{nm}$ $R=0.707R$ Max.	BW		125		MHz
RMS Noise Output Voltage	$P_{IN}=0\ \mu\text{W}$ 75 MHz, 3 pole Bessel filter on output	$V_{NO}$		0.52	0.58	mV
	No filter on output	$V_{NO}$			0.7	mV
Output PSRR <sup>3</sup>	F=10 MHz			20		dB
Output Overshoot	$P_{IN}=10\ \mu\text{W}$			10	13	%
Output Resistance	F=50 MHz			20		$\Omega$
RMS Input Noise Power @ 25°C <sup>4</sup>	$P_{IN}=0\ \mu\text{W}$ 75 MHz, 3 pole Bessel filter on output	$P_{IN}$		-41.3	-41.0	dBm
				0.074	0.079	$\mu\text{W}$

## Notes:

\* Typical specifications are for operation at  $T_A = 25^{\circ}\text{C}$ .

\*\* Photodiode has 600  $\mu\text{m}$  (0.024 in) diameter glass ball lens for optical coupling.

\*\*\* Output pin should be AC coupled at a 511 Ohm load. Load capacitance <50 pF (see circuit diagram).

\*\*\*\* Quiescent output voltage ( $V_{ODC}$ ) =  $V_{CC} - 3.65\ \text{V}$  typical. Dynamic output voltage swing is above the quiescent output voltage ( $V_O = V_{ODC} + R \times P_{IN}$ ).

1. See Figure 7 (b).

2. Measured at 50% amplitude point on the output waveform.

3. Output PSRR is defined as  $20 \log (V_{\text{supply ripple}}/V_{\text{OUT ripple}})$ .

4. Input referred noise is calculated as  $P_{HI} = V_{NO}/R$ .

FIGURE 4: SPECTRAL RESPONSE

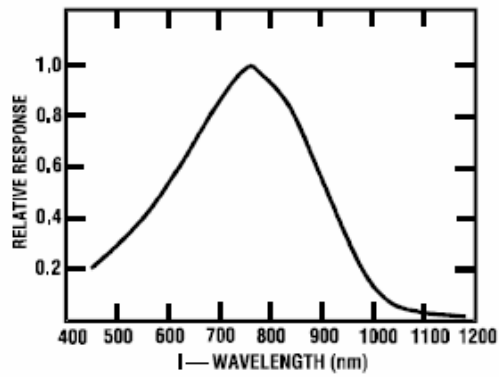

FIGURE 5: PULSE WIDTH DISTORTION VS OPTICAL INPUT POWER

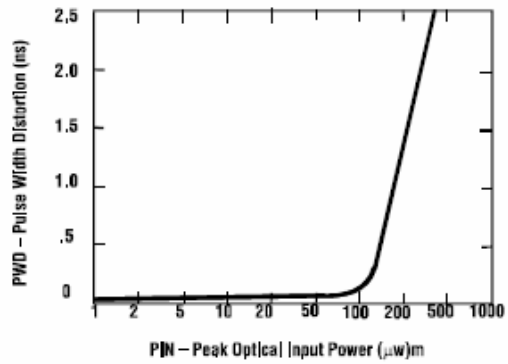

FIGURE 6: SWITCHING WAVEFORM

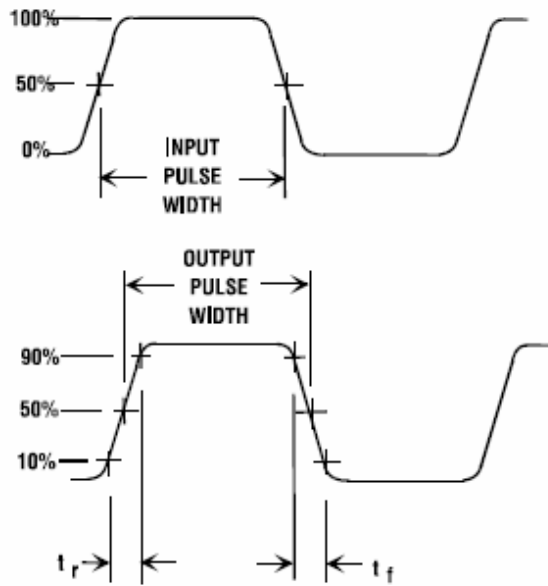
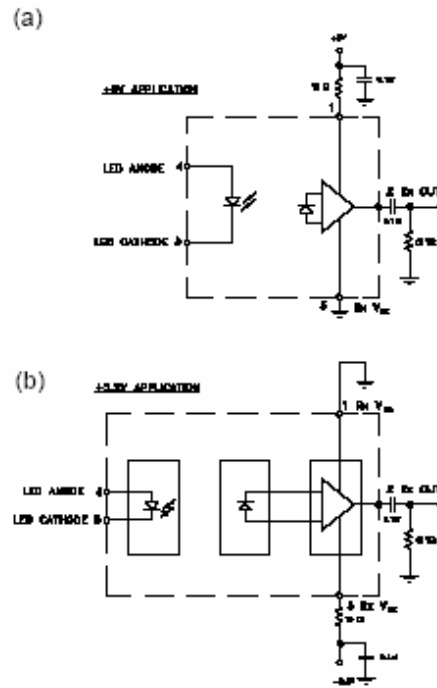
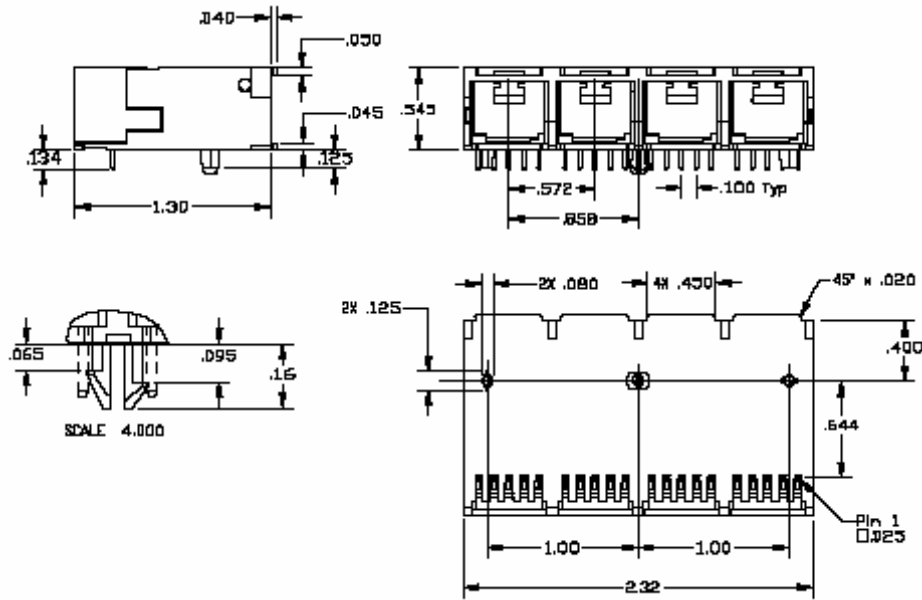

FIGURE 7: CIRCUIT DIAGRAM



**Package Outline Diagram**

Dimensions for the device package are given in inches.



**PINOUT**

Number	Function
1	RX V <sub>cc</sub>
2	RX Output
3	RX V <sub>EE</sub> GND
4	LED Anode
5	LED Cathode

**Additional Information**

**Contact**

For additional information, product specifications, or information about Optocom:

Internet: <http://www.optocom.com>

Email: [sales@optocom.com](mailto:sales@optocom.com)

Tel: +1 978 988 8711

Fax: +1 978 988 8722

©2005 Optocom Corporation. All rights reserved. Information in this document is believed to be accurate and reliable and is subject to change without notice. Optocom Corporation will not be held liable for technical or editorial errors or omissions contained herein. Reproduction in whole or in part is prohibited without prior written consent of the copyright owner and no responsibility will be assumed by Optocom Corporation for any infringements of third parties. All other brand or product names mentioned are the trademarks or registered trademarks owned by their respective companies or organizations.